

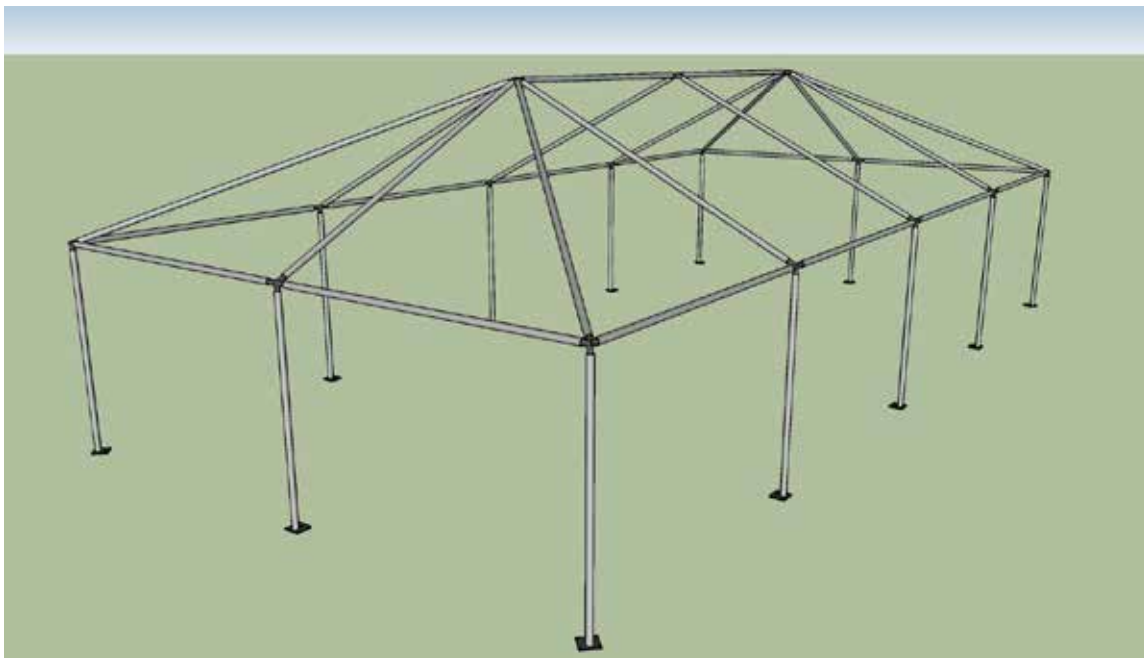

Ohenry 20'x40' High Peak Frame Tent



Ohenry Productions Inc. 3859 Chappel Hill Rd. Waco, TX. 76705
(254)714-1103 Office (254)714-1117 Fax

Ohenry 20'x40' Frame Tent

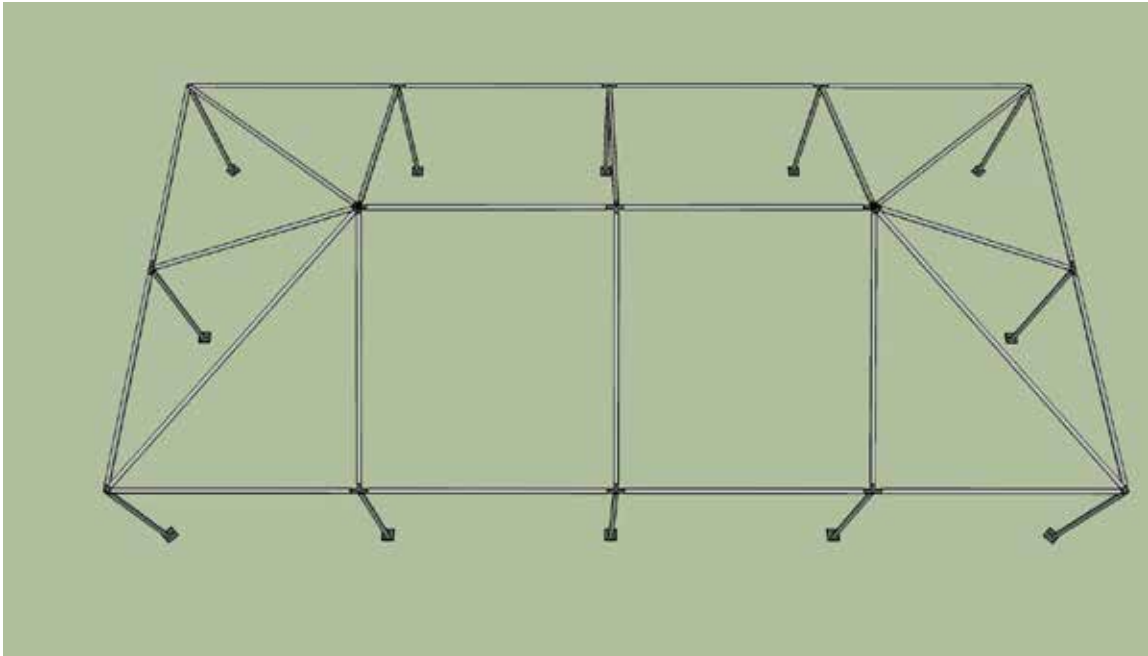
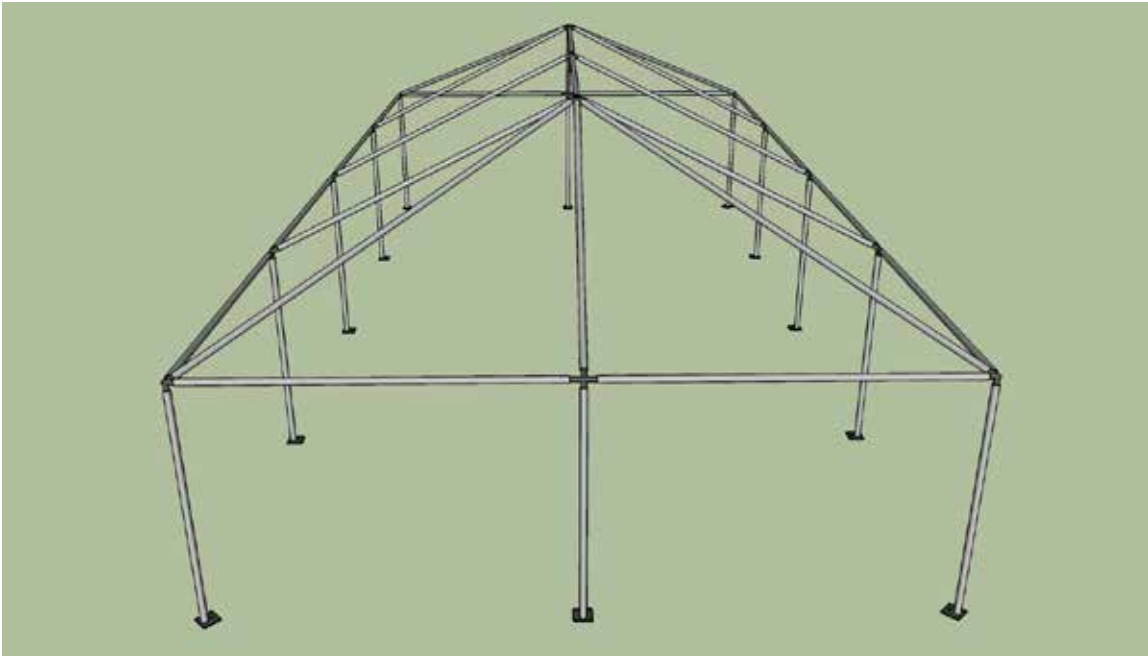





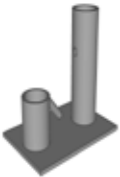

Ohenry Productions Inc. 3859 Chappel Hill Rd. Waco, TX. 76705
(254)714-1103 Office (254)714-1117 Fax

Fittings	
4	Corner Fitting
2	6 Way Crown
8	Side T Joint
1	Ridge Top T's
12	Premium Base Plates
82	Canopy Pins
12	Guy Ropes
12	24" Stakes
12	1" Ratchets

Poles		
4	14' 4"	Hip Rafters
8	10' 6"	Rafters
14	9' 4"	Spreaders
12	6' 8"	Legs

Mast Parts	
2	End Masts
2	End Mast Inserts

Part Identification	
 <p>6 Way Center Crown</p>	 <p>Premium Base Plate</p>
 <p>Side T</p>	 <p>Ridge Top T</p>
 <p>Corner Fitting</p>	 <p>Canopy Pin</p>
 <p>End Mast</p>	 <p>End Mast Insert</p>

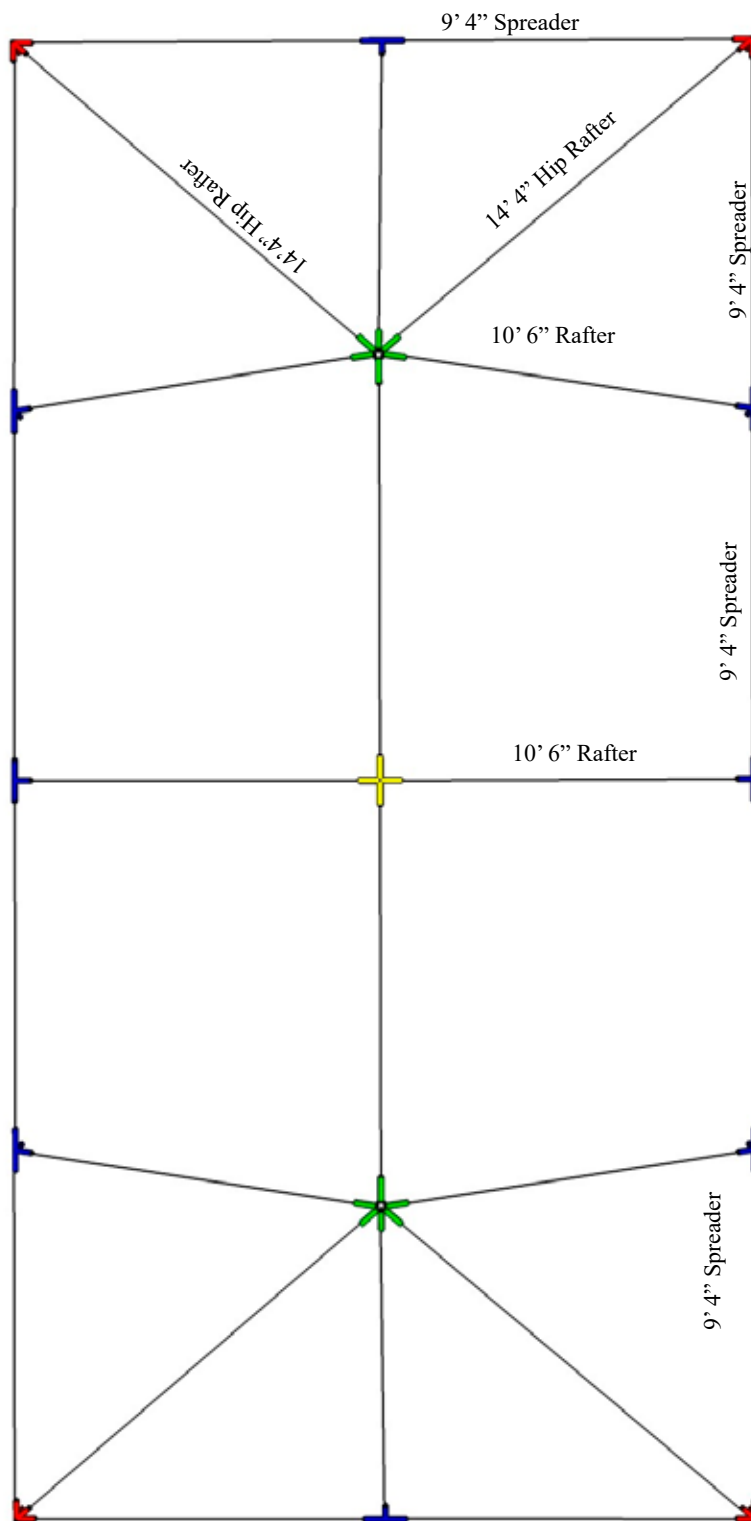

Ohenry Productions Inc. 3859 Chappel Hill Rd. Waco, TX. 76705
 (254)714-1103 Office (254)714-1117 Fax

“OHENRY WEST COAST FRAME TENT” ASSEMBLY INSTUCTIONS
10' wide – 20' wide

All tubing is labeled for easy Identification.

Please verify the parts with the chart provided before you begin assembly.

Assembly Steps:

1. Lay out the Spreader pipes and Corner Fittings in a square or rectangle (refer to previous page). Lay out Hip Rafters and Rafters and Side T Joints. Place Center Crown(s) in the center of the tent.

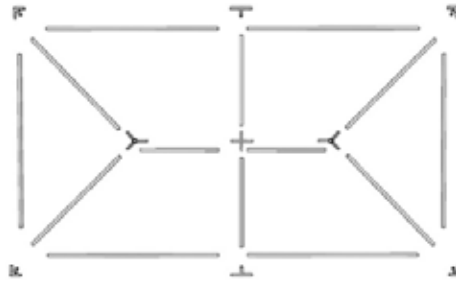

2. Start assembling the frame by inserting and pinning the Hip Rafters into the Center Crown(s). If assembling a rectangular frame insert and pin the appropriate Spreader into the Center Crown and continue to the next Ridge Top T or Center Crown. Insert and pin Rafters into the Crowns and Ridge Top T's. Insert and pin all Corner Fittings and Side T Joints to the bottom of the Hip Rafters and Rafters.

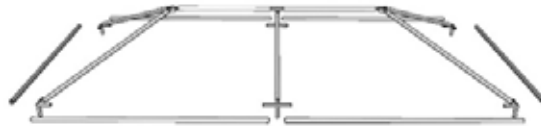

3. Start at one corner of the frame and insert and pin the Corner Fitting to the Spreader. Continue in one direction around the frame inserting and pinning each fitting to the Spreader.



4. Unfold the tent cover on the ground next to the assembled frame. Place the cover on the frame. Be sure to center the cover while the upper structure is still on the ground.



5. Lift one side of the tent and attach the legs (with base plates) and insert the pins. It is recommended that two people be available when lifting the frame to install legs.

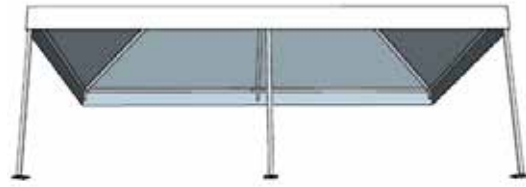

<p>6) Take the Mast Insert and insert it into the 3-way crown from the Top of the 6-way Center Crown.</p>	A diagram showing a vertical Mast Insert being pushed into a 3-way crown. A downward-pointing arrow indicates the direction of insertion.
<p>7) Secure the Mast Insert to the center crown with the strap and buckle provided so the insert does not move when you insert the mast later.</p>	A diagram showing the Mast Insert secured to the center crown. A strap with a buckle is wrapped around the crown and the insert to hold it in place.
<p>8) Remove the top cap from the round End Mast and insert the mast into the Mast Insert from the bottom (underneath the tent).</p>	A diagram showing a round End Mast being inserted into the Mast Insert from the bottom. An upward-pointing arrow indicates the direction of insertion.
<p>9) Take the removable mast top with pin, insert pin through the hole in tent top, then insert the top piece into the mast and pin in place with the canopy pin.</p>	A diagram showing the removable mast top with a pin being inserted into the mast. The pin is shown passing through the top of the mast into the canopy.
<p>10) Next push the mast all the way up until the two holes in the Mast Insert align with the two holes at the bottom of the mast. Secure with two canopy Pins.</p>	A diagram showing the mast being pushed up until the two holes in the Mast Insert align with the two holes at the bottom of the mast. Two canopy pins are shown securing the mast to the canopy.

11. Lift the other side of the tent and attach the legs (with base plates).

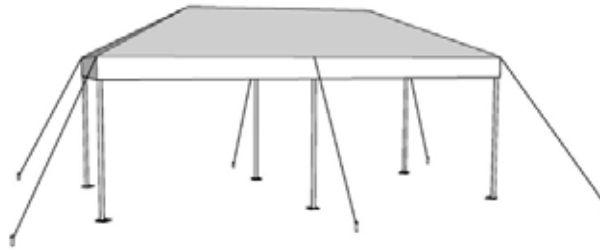

12) Next you will attach the end of the ratchet strap which has the metal clip (ratchets are included with your tent top) to the rings in the tent top at the corners and depending on size, the other locations on the tent top perimeter which have rings attached. Next attach the other end of each ratchet which has a ring attached to the base as shown in the photograph below. Tighten ratchet enough to have a slight tension. Do the same for each leg. Be sure tent is aligned correctly on the frame, and then retighten all the ratchets attached to the tent top and base plates as shown.

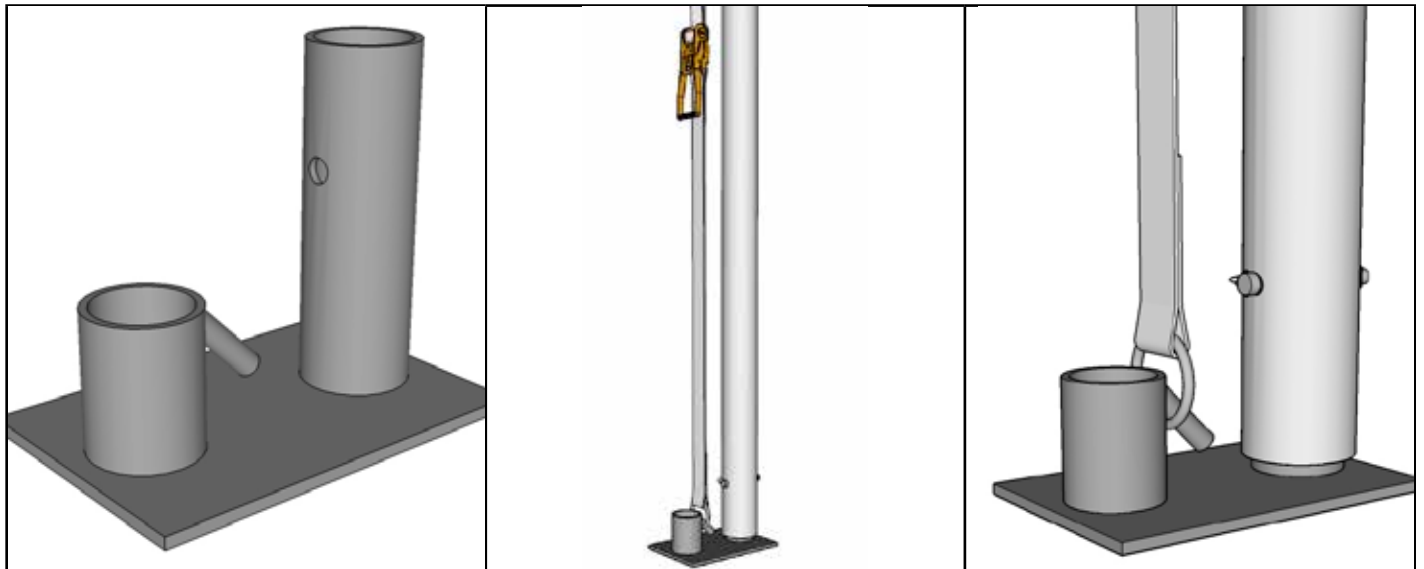

12. At each leg, now drive a tent stake into the ground about 5' from the edge of the tent. Attach the Guy Ropes provided with your tents and tighten securely to the tent stake. provided. **In the event of high winds, the cover should be removed from the frame to prevent damage to your tent. Your tent should be vacated during inclement weather.**